

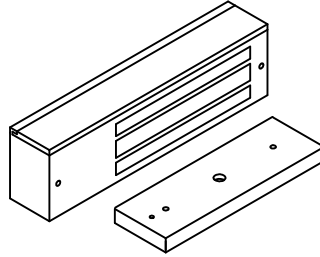

INSTALLATION INSTRUCTIONS

EZ-1511, 1571



OPTIONAL FEATURE KITS

EZ-D-10

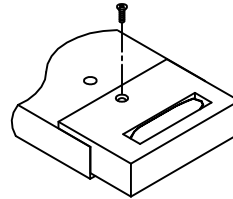
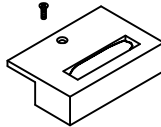

EZ-T-10

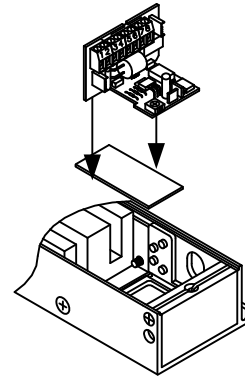
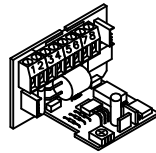

EZ-A

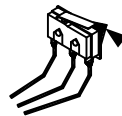

REMOVE
BACKING
ON TAPE



EZ-1512, 1572

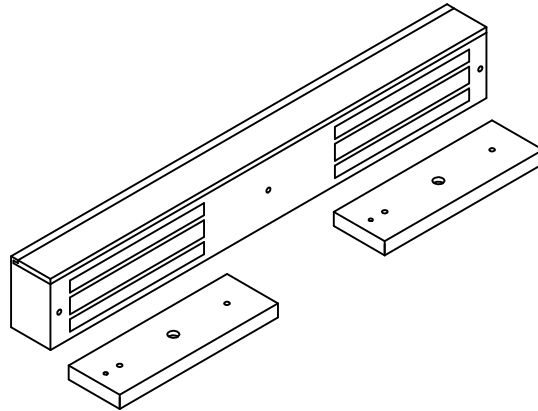

OPTIONAL FEATURE KITS

EZ-D-10

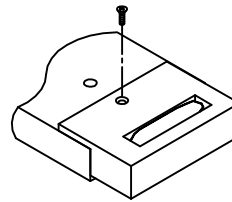
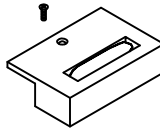

EZ-T-10

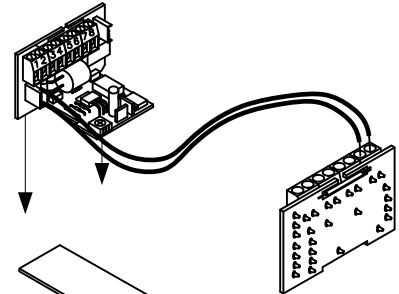
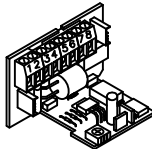

EZ-A

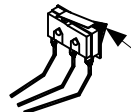

REMOVE
BACKING
ON TAPE

